



DESIGNLIGHT

SCANDINAVIAN AB

TRACKY ONE TRACKLIGHT

E-NR: 74 030 88

ART NR: P-807B

EFFEKT POWER	MATERIAL MATERIAL	KELVIN KELVIN	ARMATURFÄRG ARMATURE COLOR	ANSLUTNING CONNECTION	TOTAL LUMEN	USEFUL LUMEN
3x7,4W WITH DRIVER	ALUMINIUM	3000K	MATT BLACK	230V	3x595LM	3x591LM

RoHS CE



LIFETIME L70B50: 50.000H

- KOMPLETT OCH FLEXIBEL
- KOMPACT OCH DISKRET LJUSSÄTTNING

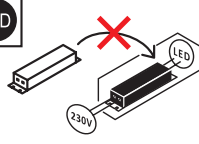

- COMPLETE AND FLEXIBLE
- COMPACT AND DISCREET LIGHTING



STARTPAKET 3 LAMPOR + 1M SKENA (1-FAS)

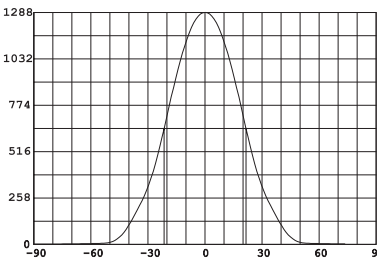
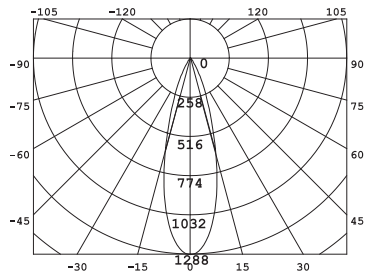

Avstånd	Belysningsstyrka	Spridningsvinkel 36°	Diam.
32.18cm	3520, 51541lx		32.18cm
64.36cm	880.0, 12881lx		64.36cm
96.54cm	391.1, 572.61lx		96.54cm
128.72cm	220.0, 322.11lx		128.72cm
193.08cm	97.78, 143.21lx		193.08cm

1. Stäng av strömmen/Turn off the power
2. Turn the switch to unlock position to conceal the metal contacts on adaptor, before install the spot light into track.

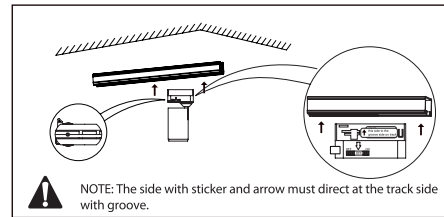

3. Turn the switch anticlockwise to lock the adaptor, after inserting the spot light into track.

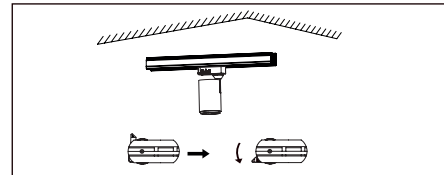

4. Turn the switch on adaptor to ON until a clear click sound to get power on, indicated by the arrow.

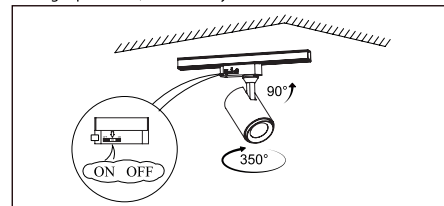

Mått/Dimension

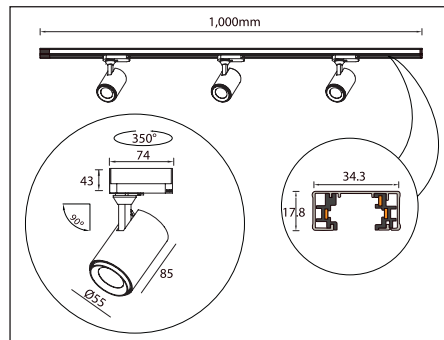

PRODUKTEN INNEHÅLLER
LJUSKÄLLA MED
ENERGIMÄRKNING
KLASS F.

THIS PRODUCT CONTAINS
A LIGHT SOURCE OF
ENERGY EFFICIENCY
CLASS <F>.

SAKERHET:

1. Läs igenom hela manualen noggrant före installation.
2. Försäkra dig om att spänningen är frånslagen före installation eller underhåll.
3. Installation ska utföras av behörig elektriker.
4. Ljuskällan är ej utbyttbar. Hela armaturen måste bytas när ljuskällan är förbrukad.

SAFETY:

1. Read the entire manual carefully before installation.
2. Make sure that the power is switched off before installation or maintenance.
3. Installation must be performed by a qualified electrician.
4. The light source of this luminaire is not replaceable; when the light source reaches its end of life the whole luminaire shall be replaced.



1.900K	2.700-3.000K	4.000-4.500K	4.800K	5.000-5.000K	7.000-7.500K	10.000K
STEARINLJUS CANDLE	VARMVIT WARM WHITE	NATURLIG VIT NATURAL WHITE	SOLLJUS DIRECT SUN	VITT DAGSLJUS DAY WHITE	KALLVIT COOL WHITE	BLÅ HIMMEL BLUE SKY



LÄS MER OM VÅRA GARANTIVILLKOR PÅ WWW.DESIGNLIGHT.NU

READ MORE ABOUT OUR WARRANTY CONDITIONS AT: WWW.DESIGNLIGHT.NU

DESIGNLIGHT
SCANDINAVIAN AB

DESIGNLIGHT SCANDINAVIAN AB · Toffelvägen 1 · SE-342 60 Moheda · SWEDEN
Telefon/Phone +46 (0)472-716 10 · info@designlight.nu · designlight.nu