



DESIGNLIGHT

SCANDINAVIAN AB

Art nr.: S25-1200D

E-nr:

Watt	Material	Kelvin	CRI	Armaturfärg	Effekt	Lumen(lm)
Watt	Material	Kelvin	CRI	Armature color	Effect	Lumen(lm)
1200W	Aluminum	4000K	>70	Gray	135lm/W	162,000LM
1200W	Aluminum	4000K	>90	Gray	115lm/W	138,000LM

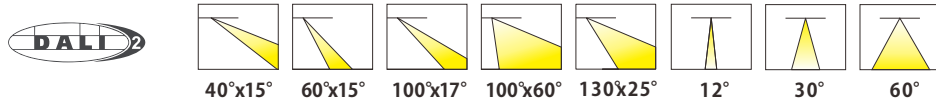

- 135lm/w med lens, driver
- 180lm/w utan lens, driver
- CRI Värde>70/>90
- 135lm/w with lens and driver
- 180lm/w without lens and driver
- CRI>70/>90

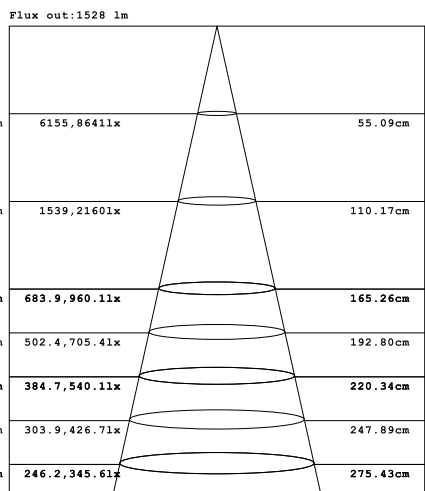
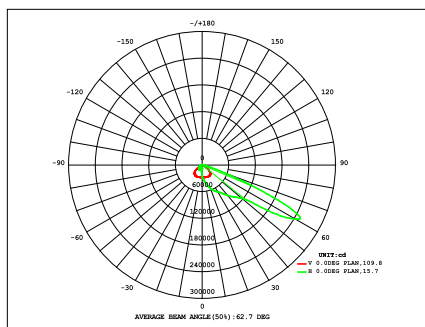

Note: The Curves indicate the illuminated area and the average illumination when the luminaire is at different distance.

Installation

This Modular floodlight can be installed on pole, wall, ceiling or on a horizontal surface.

Note: Considering the heat dissipation, load bearing and dust accumulation, some installation methods are not allowed.

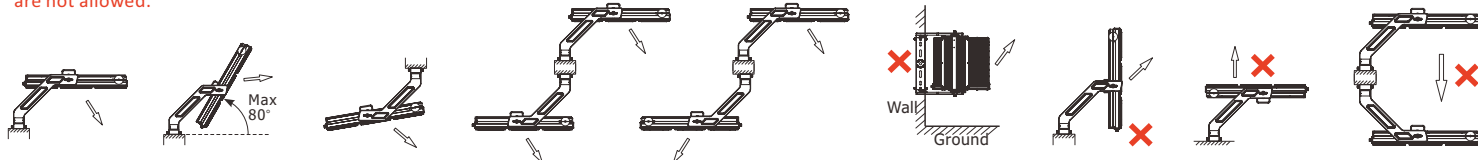

Komi håg vid montering av LED-strålkastare

1. Installation och underhåll får endast utföras av behörig installatör.
2. Ljuskällan till denna armatur är inte utbyttbar, när den förbrukats ska hela armaturen bytas ut.
3. Notera att förändringar i kabelinstallation kan påverka IP-klassning.
4. Se till att fästskruvar fixeras med fjäderbricka och dras åt ordentligt.
5. Jordledning måste vara väl ansluten.
6. Se till att strålkastaren är ansluten till korrekt ingångsspänning.
7. Använd inte kemikalier eller frätande rengöringsmedel för att rengöra armaturen.
8. Minsta avstånd från belysta objekt till armaturer ska vara minst 0,3 m.
9. Trasig lins måste bytas ut av certifierad tekniker.

Separated control gear solution



Connection of luminaire

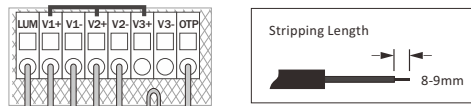

Dimensions

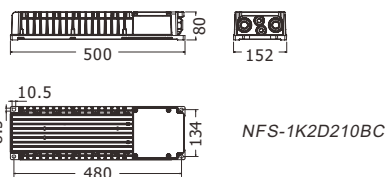
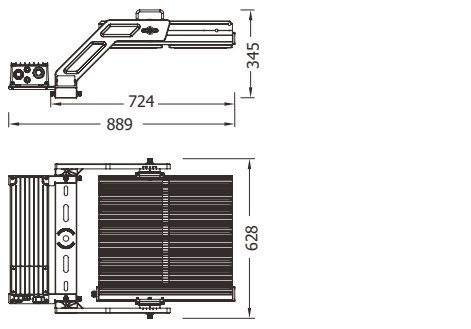

Things to remember when installing LED Floodlights

1. Installation and maintenance must be performed by professionals only.
2. The light source of this luminaire is not replaceable; when the light source reaches its end of life the whole luminaire shall be replaced.
3. Note that changes in cable installation may affect IP rating.
4. Please make sure the hook was fixed with spring washer and tighten up.
5. Ground wire must be well connected.
6. Please make sure the lamp is working with correct input voltage.
7. Do not use chemicals or corrosive cleaner to clean the fixture.
8. The minimum distance from lighted objects to luminaries shall be kept at least 0.3m.
9. Broken Glass must be replaced by certified technician.

Mounting bracket

