



DESIGNLIGHT

SCANDINAVIAN AB

DOWNLIGHT, 10-PACK

E-NR: 74 746 47

ART NR: Q-32MW-10

EFFEKT POWER	MATERIAL MATERIAL	KELVIN KELVIN	ARMATURFÄRG ARMATURE COLOR	ANSLUTNING CONNECTION	TOTAL LUMEN	USEFUL LUMEN
10x1,2W	ALUMINIUM	3000K	MATT WHITE	350MA	10x115LM	10x104LM

ROHS CE

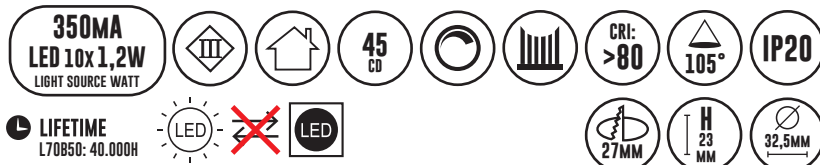

- SNYGGT ACCENTLJUS
- STORT ANVÄNDINGSOMRÅDE

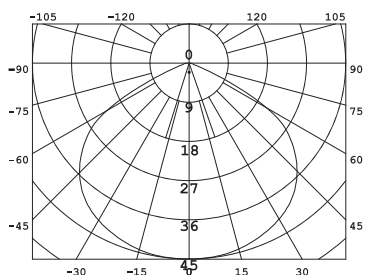
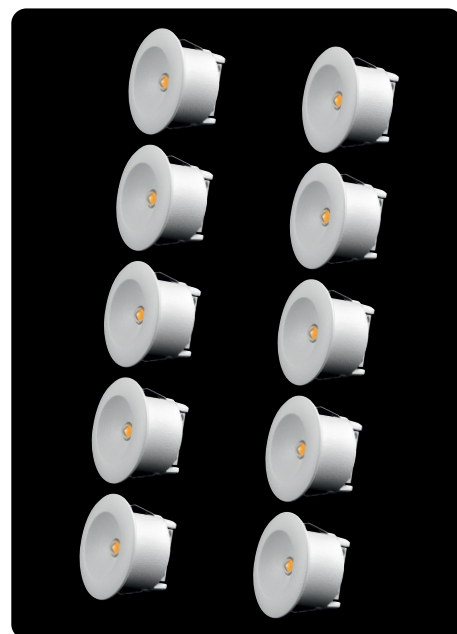

θav (50%)=105°

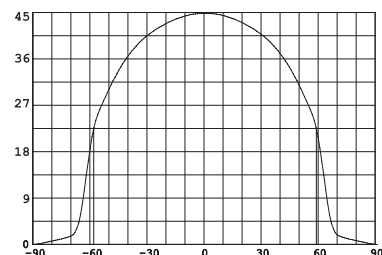

Avstånd	Belysningsstyrka	Spridnings vinkel 105°	Diam.
0.50m	47.47lx	172.5lx	164.31cm
1.00m	11.87lx	43.13lx	328.61cm
1.50m	5.27lx	19.17lx	492.92cm
2.00m	2.96lx	10.78lx	657.23cm
3.00m	1.31lx	4.78lx	985.84cm

1. Stäng av strömmen/Turn off the power
2. Borra hål i taket/Drill hole in ceiling

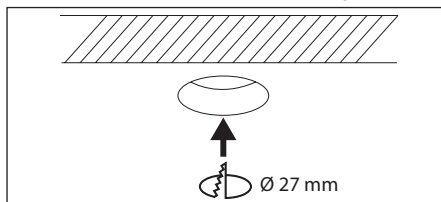

3. Anslut till LED-drivern/Connect to LED driver

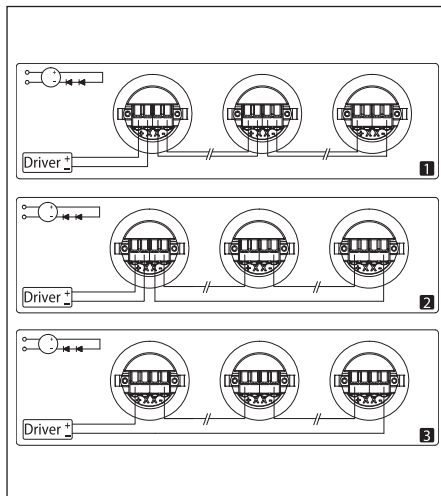

Mått/Dimension

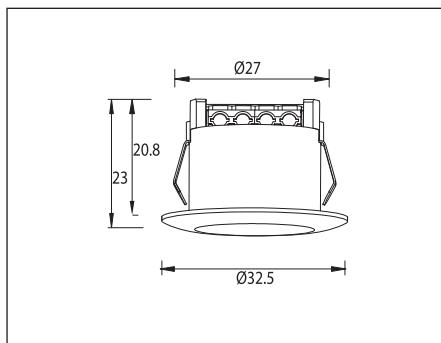

Designlight Scandinavian AB
Q-32MW-10

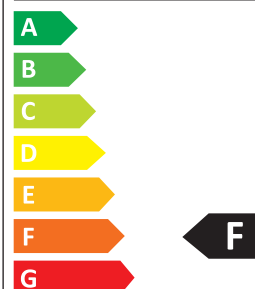

1 kWh/1000h



2019/2015

! SÄKERHET:

1. Läs igenom hela manualen noggrant före installation.
2. Kontrollmät ALLTID diametern före håltagning i tak.
3. Kontrollera att drivdonet är anpassat för det antal lampor som ska installeras.
4. Försäkra dig om att spänningen är fränslagen före installation eller underhåll.
5. Installation ska utföras av behörig elektriker.
6. Ljuskällan är ej utbytbar. Hela armaturen måste bytas när ljuskällan är förbrukad.

! SAFETY:

1. Read the entire manual carefully before installation.
2. ALWAYS check the diameter before drilling holes in the ceiling.
3. Check that the driver is adapted to the number of lamps to be installed.
4. Make sure that the power is switched off before installation or maintenance.
5. Installation must be performed by a qualified electrician.
6. The light source of this luminaire is not replaceable, when the light source reaches its end of life the whole luminaire shall be replaced.



1.900K	2.700-3.000K	4.000-4.500K	4.800K	5.000-5.000K	7.000-7.500K	10.000K
STEARINLJUS CANDLE	VARMVIT WARM WHITE	NATURLIG VIT NATURAL WHITE	SOLLJUS DIRECT SUN	VITT DAGSLJUS DAY WHITE	KALLVIT COOL WHITE	BLÅ HIMMEL BLUE SKY

LÄS MER OM VÅRA GARANTIVILLKOR PÅ WWW.DESIGNLIGHT.NU READ MORE ABOUT OUR WARRANTY CONDITIONS AT: WWW.DESIGNLIGHT.NU

DESIGNLIGHT
SCANDINAVIAN AB

DESIGNLIGHT SCANDINAVIAN AB · TOFFELVÄGEN 1 · SE-342 60 MOHEDA · SWEDEN
TELEFON/PHONE +46 (0)472-716 10 · INFO@DESIGNLIGHT.NU · WWW.DESIGNLIGHT.NU