



PLAFOND PIR, PLAFONDY

E-nr: 70 284 03

Art nr: PL008-1771

Effekt Power	Material Material	Kelvin Kelvin	Armaturfärg Armature color	Anslutning Connection	Total Lumen (lm)	Useful Lumen (lm)
18W	PC Anti-UV	2700K 3000K 4000K	Matt vit Matt white	230V	1833 1982 1952	1833 1982 1952



- Justerbar färgtemperatur
- Kompakt & tålig
- Enkel installation

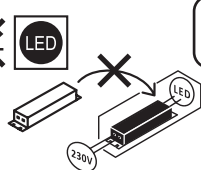

- Adjustable color temperature
- Compact & durable
- Easy installation



SWITCHABLE
2700K/3000K/4000K

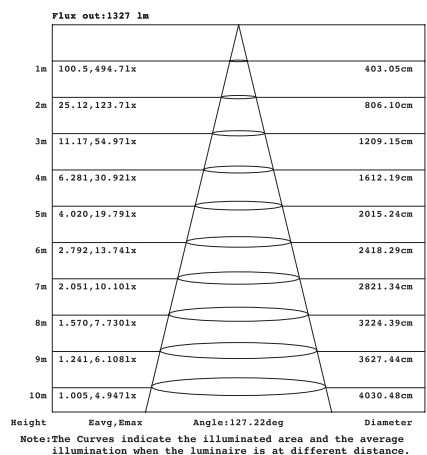
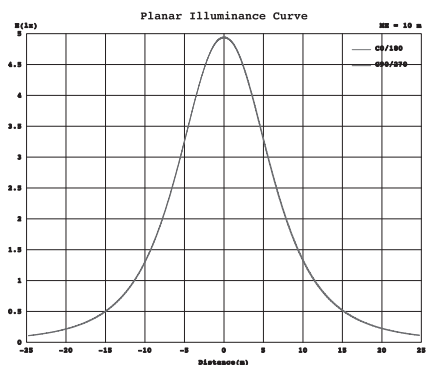
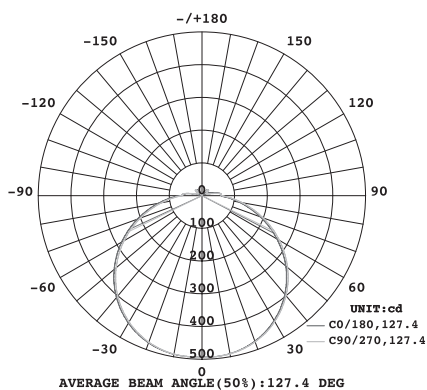

Mått/Dimension

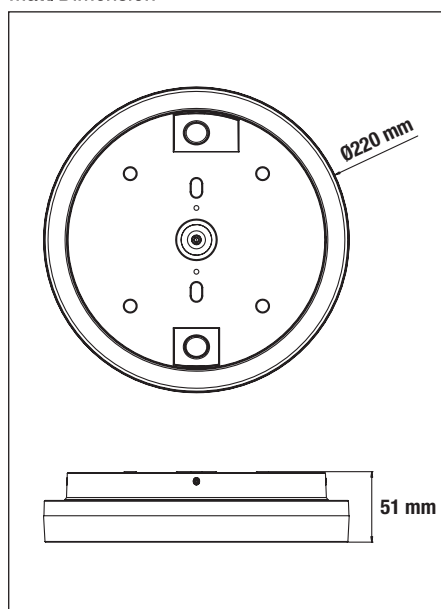

Antal armaturer per säkring/ Number of light fittings per fuse

B10	B16	C10	C16
80	120	80	120

Designlight Scandinavian AB
PL008-1771

A
B
C
D
E
F
G

18
kWh/1000h

2019/2015

⚠ SÄKERHET

- 1 Läs igenom hela manualen noggrant före installation.
- 2 Försäkra dig om att spänningen är frånslagen före installation eller underhåll.
- 3 Installation ska utföras av behörig elektriker.

⚠ SAFETY

- 1 Read the entire manual carefully before installation.
- 2 Make sure that the voltage is switched off before installation or maintenance.
- 3 Installation must be performed by a qualified electrician.



INSTALLATION

Montering / Mounting Procedure

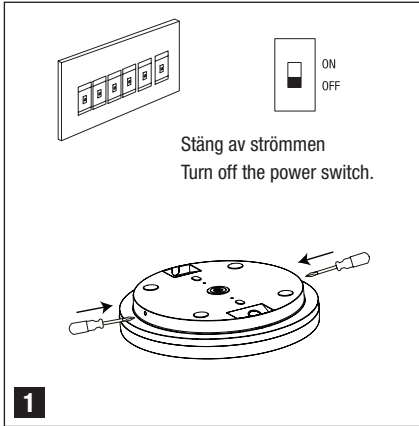
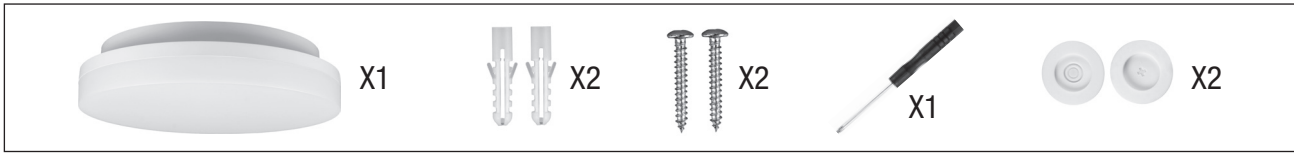

Öppna lampan.
Open the lamp.

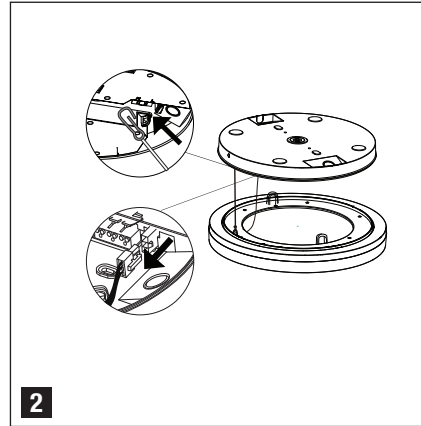

Lossa säkerhetslina och kablar.
Take off the safety rope and the input cable.

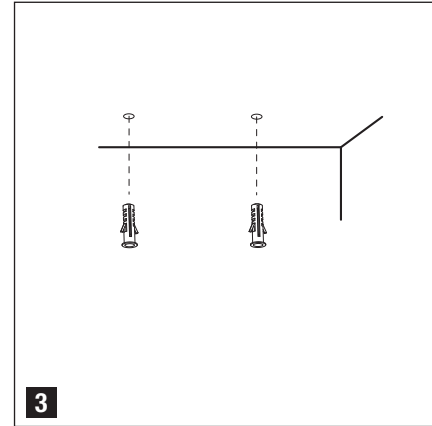

Borra expansionskruv.
Drill expansion screw.

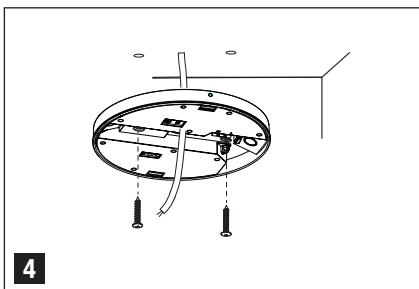

Anslut nätkabeln. Fäst drivenhetens basplatta med skruvar.
Connect ac power wire. Fix the driver base plate by screws.

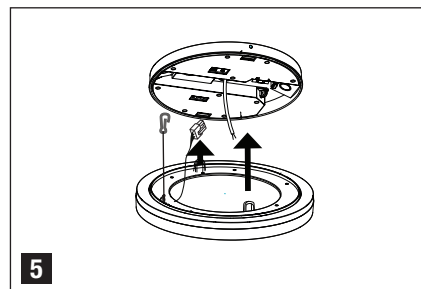

Sätt tillbaks lampenheten.
Install the lighting cover.

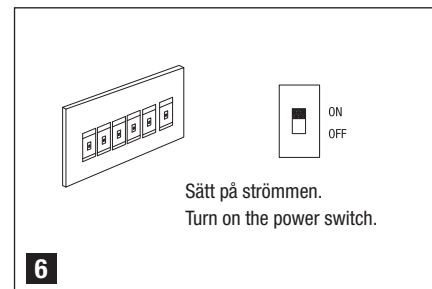

FÖRBRUKADE ARMATURER / WASTE OF ELECTRICAL AND ELECTRONIC EQUIPMENT

LED-lampor måste kasseras i enlighet med gällande regler för miljöskydd. Förbrukade armaturer ska lämnas som elektronikskrot till miljö/återvinningscentral där de tas emot utan kostnad. Korrekt retur av uttjänt elektronikutrustning gör det möjligt att bevara värdefulla miljöresurser och undvika negativa effekter på hälsa och miljö, vilket kan hotas av olämplig avfallshantering.

LED lamps must be disposed in accordance with current regulations for environmental protection. Used luminaires must be handed over as electronic waste to an environmental/recycling center where they will be accepted free of charge. Correct return of end-of-life electronic equipment makes it possible to preserve valuable environmental resources and avoid negative effects on health and the environment, which can be threatened by inappropriate waste management.

